

Position	Amount	Type number	Description	PG
1	1	1395207098	SAW SPINDLE BOLT M 8 LH X20 VERZ.	16
2	1	1485212147	BLADE COLLAR, OUTER	23
3	4	141122530	Self-tap. fill. h. screw	10
4	1	2380213993	HOUSING COVER	30
6	1	1485212139	Flange	27
7	1	141180170	Retaining ring	10
8	1	1010656504	RETRACTABLE BLADE GUARD MIT VERRIEGELUN	35
9	1	6176007417	COUNTERSUNK HEAD TAPPING SCREW ST 3,5X16	10
10	1	7100047262	DEEP GROOVE BALL BEARING 6X19X6 626 -2Z	15
21	9	6172028215	Fillister head screw	10
23	1	1492037601	MOTORHEAD CATCH BL 2,99X(53)X264	15
25	1	7051202958	RETURN SPRING RDA 9X30X0,8	10
26	1	6104220876	Hex fit bolt	13
27	1	8242033664	STRAIN RELIEF	10
28	1	8050033539	CAPACITOR 20uF/400V 45X67 KABEL 160 ABGE	25
29	5	6172032905	CROSS REC'D PAN HEAD TAP.SCREW ST 3,5X16	10
32	1	1010655575	LID, TERMINAL BOX 230/1/50 M.E-BREMSE VE	56
33	1	1492037580	COVER STRIP LS 25X5X150	12
34	5	141122540	Self-tap. fill. h. screw	10
36	1	1392202729	FASTENING STRAP FL 30X8X96	23
38	1	1010657080	MOTOR, CROSSCUT AND MITRE SAW 230/1/50 E	61
39	1	9103202881	LOCK BAR RD 5X150	12
40	3	141150010	Washer	10
41	5	141113870	Cap screw	12
42	2	2391202551	FAN COVER	13
43	1	2391203442	FAN WING TYP 56	14
44	4	6143036802	HEXAGON HEAD SCREW M 5X10 VERZ.	10
45	7	141130100	Hexagonal nut	10
46	1	8216656297	TERMINAL BLOCK 6-POLIG/2,5 QMM VDE 5VD4	13
48	1	2390202787	BLADE GUARD LEVER	24
50	1	2391202853	SWITCH CAP	12
51	1	2391202926	SWITCH COVER ET	12
52	1	1010656300	TOUCH-CONTACT SWITCH KGS MIT E-BREMSE	25
53	4	6131070290	CROSS RECESSED FLAT HEAD SCREW M 5X25 VE	10
54	1	6202002305	HEXAGON NUT, PREV. TORQUE TYPE	10
55	1	2391202683	MOTOR HEAD COVER	25
56	1	1485208581	BOLT	18
57	2	6306028063	SHIM RING 32X45X0,5 VERZ.	10
62	1	2391203523	POINTER RAL 3000-3003	10
63	1	7006028220	Clamping lever	24
64	1	6127027992	HEXAGON SOCKET HEAD CAP SCREW M 12X70 VE	14

65	2	7053028238	CUP SPRING 25,0X12,2X1,5 A25/GR2	12
66	1	6205028038	HEXAGON THIN NUT	10
67	2	6300016713	Washer	10
68	2	141120030	Grub screw	13
69	1	9102017894	ALLEN HEXAGON KEY	10
70	1	6300084859	MEDIUM WASHER A 13	10
75	1	1010019067	CABLE, RUBBER JACKET,PRE-ASS'D 3GX1,5X30	29
76	2	6103001356	HEXAGON HEAD SCREW M 6X16 VERZ.FLECKBESC	10
77	1	2381715992	CABLE BUSHING 17,5X13X9,5X3 KGS 301/331	12
79	1	6202128341	HEXAGON NUT, PREV. TORQUE TYPE	10
80	3	2391203906	PLUG-IN BUFFER	10
81	2	7051210284	TENSION SPRING RDA 30X91X2,8 50-170 N	17
82	2	7001017769	STARKNOB SCREW RD40/M6X23 (DIN 933) VERZ	12
84	1	7051204314	RETURN SPRING RDA 18X90X1,25	13
85	2	1010141288	FEED ROD ASSEMBLY	34
87	1	1385209408	MOTOR HEAD AXLE	30
88	1	1485209421	CHECK NUT	17
89	1	6306110550	Shim	10
90	1	1010128451	TELESCOPIC ARM CASTING RD 20	47
92	4	141113840	Cap screw	12
93	1	1482212650	LOCKING PLATE BL 1,5X26X42,5	12
94	1	1395202606	RETURN SPRING BOLT 6KT 14X80	15
96	1	1380656465	SWIVEL CASTING	36
102	1	6103001135	Hex head screw	10
105	1	2391203540	DUST EXTRACTION PORT RD 32	17
106	1	6168029746	METAL END STUD M 12X55 RUNDUMBESCHICHTET	14
107	1	1142214322	BEVEL TILT SCAL 0,50X11X62,50 0-45 GRAD	15
108	2	6172091014	Fillister head screw	10
109	1	1380654098	FENCE	36
111	2	2391202640	KERF PLATE	17
113	1	6304084047	Serrated lock washer	10
115	1	1482210348	TRANSPORT LOCK PLATE BL 2,99X37X169,5	14
116	1	6121023081	Cap screw	10
119	3	2391202772	GLIDE PIECE	10
120	1	1380653997	TURNTABLE AUSFÜHRUNG 3	47
121	1	1395202657	FITTING BOLT, THREADED RD 16X60 RUNDUMBE	19
122	1	2393203156	SLIDE BUSHING RD 16/RD 18X20	13
123	1	6127059207	Cap screw	10
124	1	2390203040	MITRE LOCK LEVER	16
125	2	6202002291	HEXAGON NUT, PREV. TORQUE TYPE	10
126	2	141151940	Washer	10
127	1	7001203104	DELTA STARKNOB M 6X75/25	14

130	1	7051202931	Pressure spring	10
131	1	7053081619	CUP SPRING	10
132	1	1010013816	STOP LEVER MIT BUCHSE	18
135	1	1141203068	ANGLE SCALE 1,00 2X46 GRAD	19
136	1	1380675052	TABLE AUSFÜHRUNG 3 KGS301	56
137	1	7056671069	FLEXIBLE EDGE GUARD 2X15+/-0,5 KGS	10
139	1	6202024139	HEXAGON NUT, PREV. TORQUE TYPE	10
141	4	7058028481	RUBBER-METAL ANTI-VIBR. MOUNT	14
145	2	6172001821	Fillister head screw	10
155	1	1482653592	GUARD PLATE BL 0,88X62X108 KGS	21

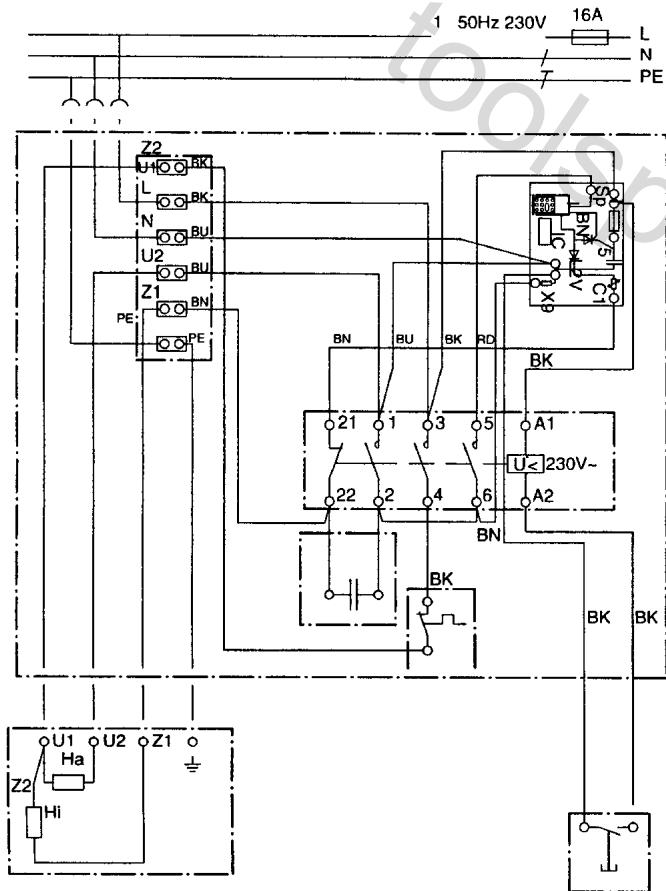

	Litzenfarben	Colour of strands	Couleur des cordons
BK	schwarz	black	noir
WH	weiß	white	blanc
BU	blau	blue	bleu
YE	gelb	yellow	jaune
RD	rot	red	rouge
TR	transparent	transparent	transparent
BN	braun	brown	brun
GY	grau	grey	gris
GNYE	grün-gelb	green-yellow	vert-jaune
BKWH	schwarz-weiß	black-white	noir-blanc
GN	grün	green	vert
OG	orange	orange	orange
VT	violett	violet	violet
TQ	türkis	turquoise	turquoise

	Bedeutung der Kurzzeichen	Meaning of the symbols	Interprétation des symboles
C	Kondensator	condenser	condensateur
D	Funkentstördrossel	interference suppression inductance	inductance d'antiparasitage
E	Elektronik-Baustein	electronic unit	unité électronique
I	Induktionsspule	induction coil	bobine d'inductance
K	Klemme	terminal	borne
L	Licht	light	lumière
M	Motor	motor	moteur
O	Überlastschutz	overload cut-out	déclencheur de surintensité
R	Drehrichtungsumschalter	reversing switch	commutateur droite-gauche
S	Schalter	switch	interrupteur
U	Umschalter	change-over switch	commutateur
X	Elektronik-Element	electronic element	élément électronique